

Part No. N30052
 EI30 x 5.0 Low Profile Double Section
 'N' Range Bobbin.

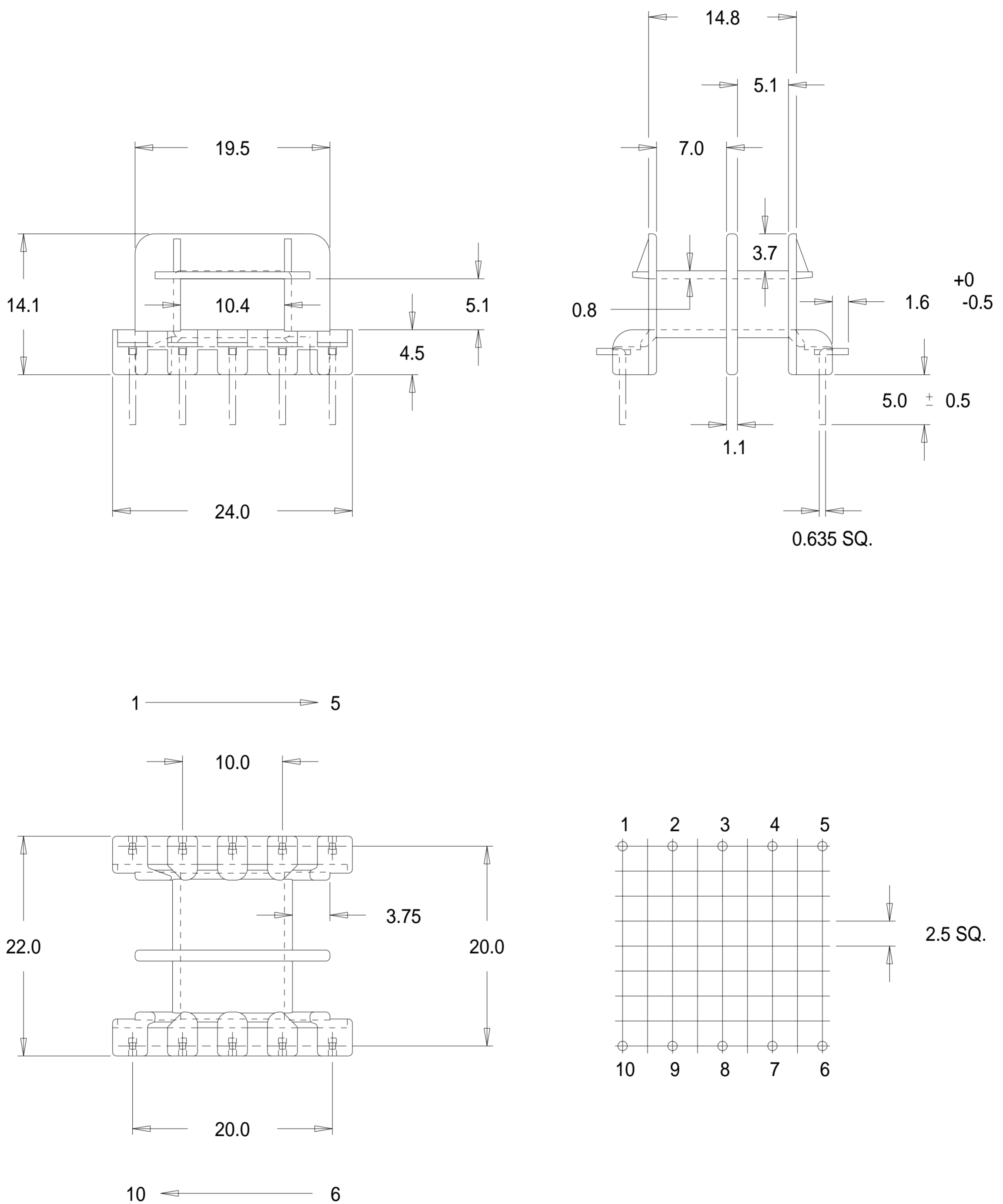

Dimensions in millimetres.

