

Part No. N30059

EI30 x 5.0 Low Profile 'N' Range Box

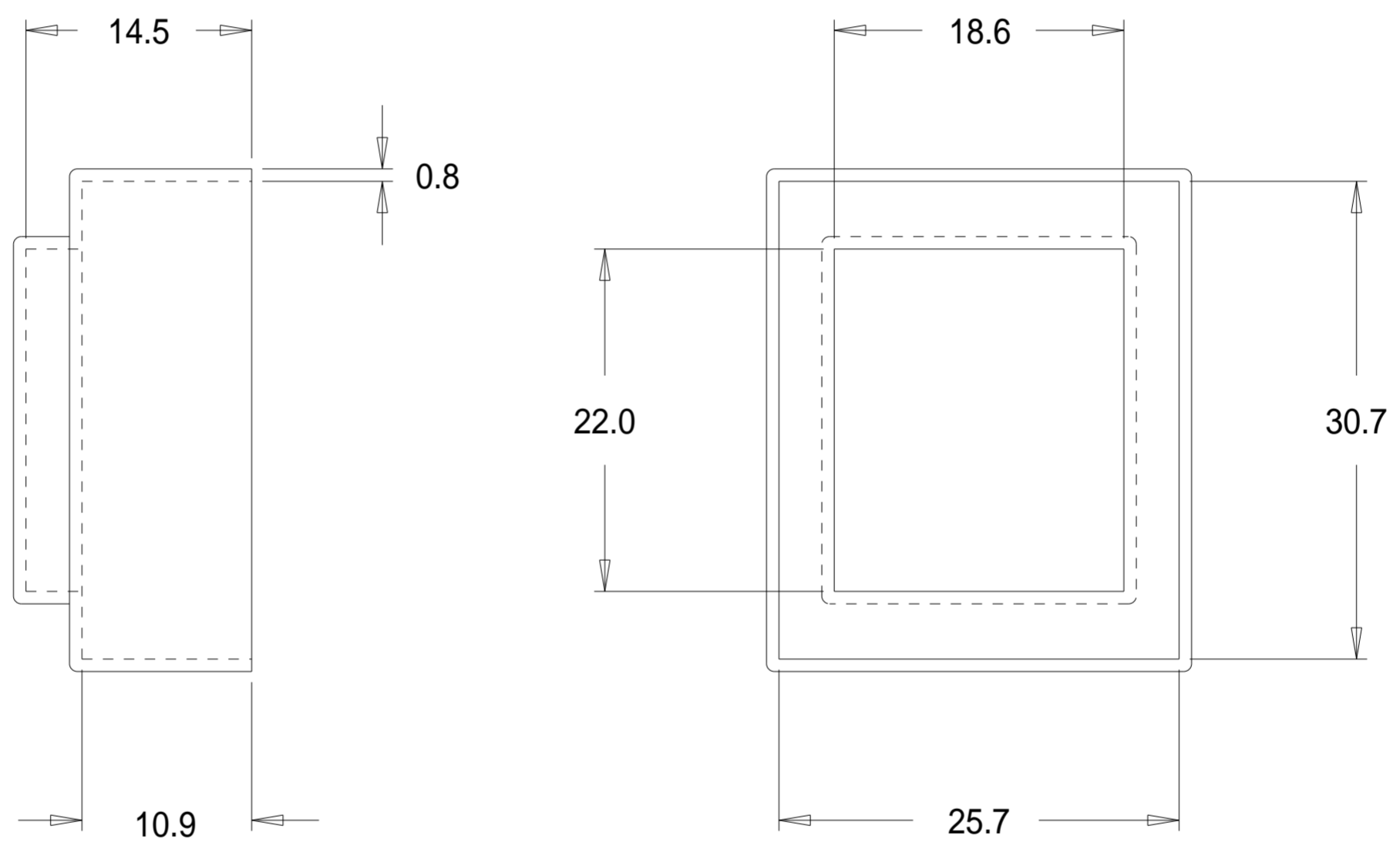

Dimensions in millimetres.

