

Part No. N30122
 EI30 x 12.5 Low Profile Double Section
 'N' Range Bobbin.

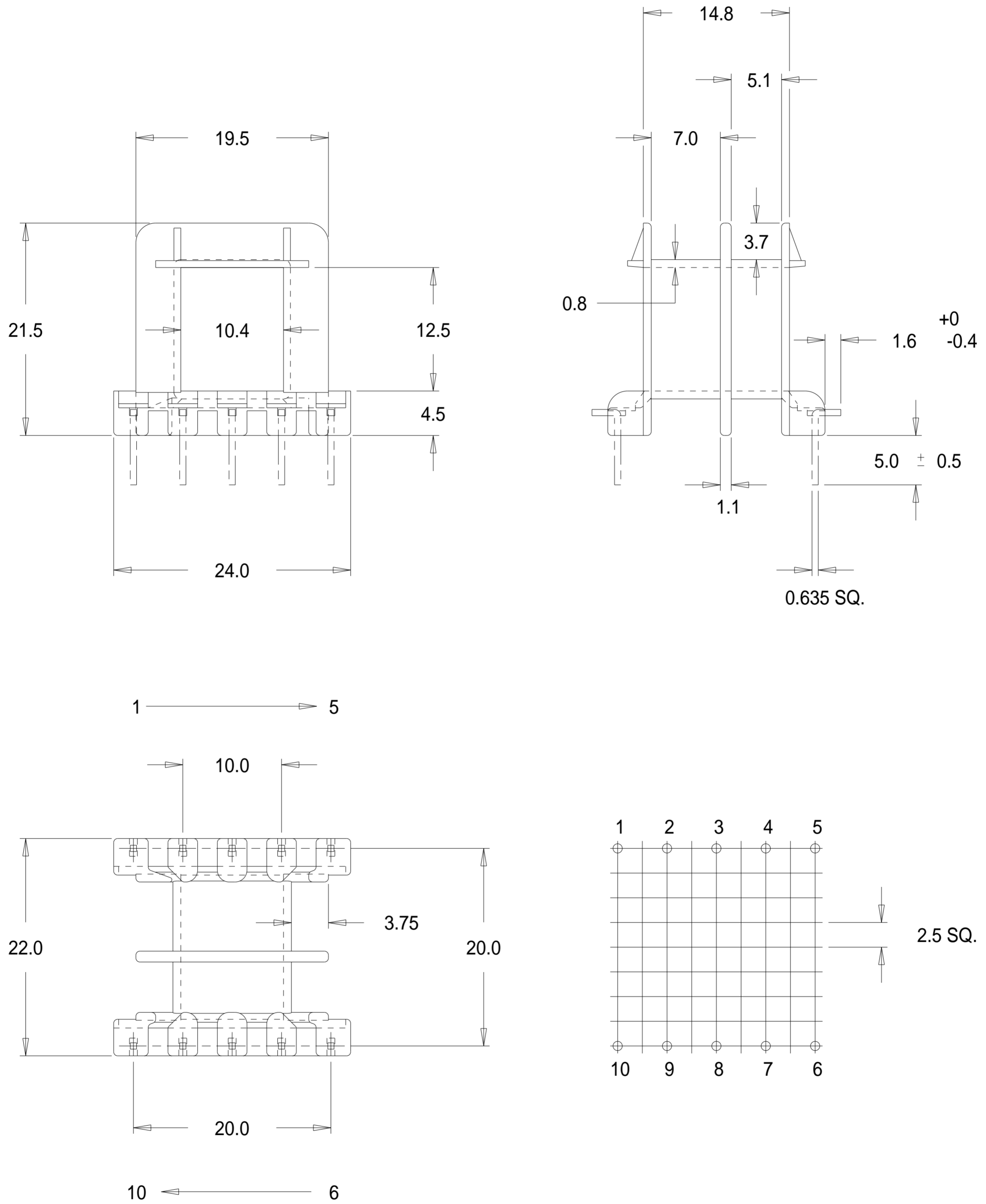

Dimensions in millimetres.

