

Part No. TR0010
Toroid Mount (72958)

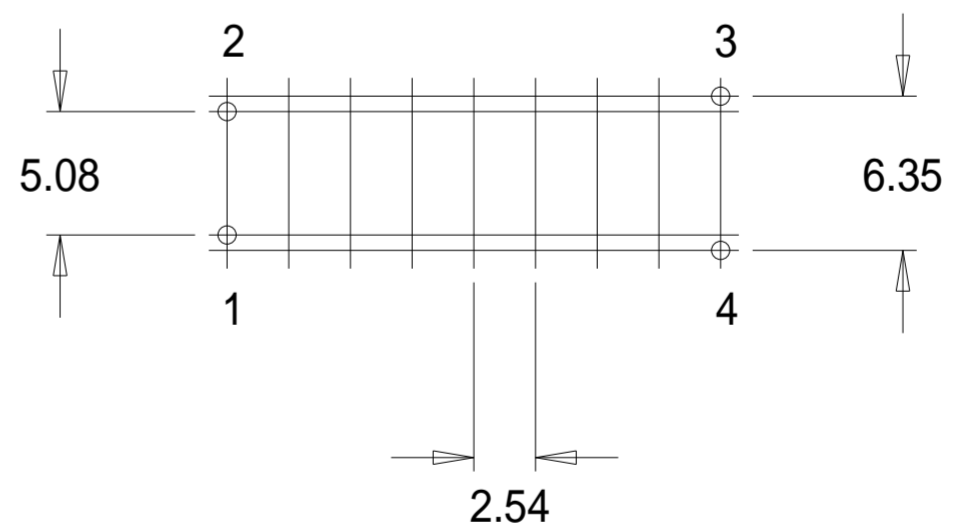

Dimensions in millimetres.

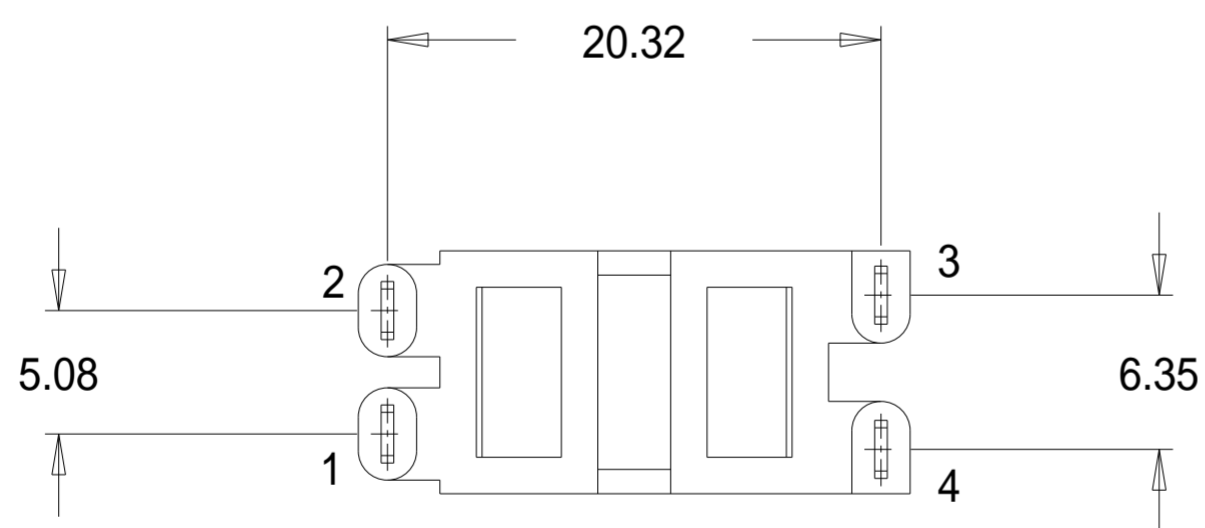
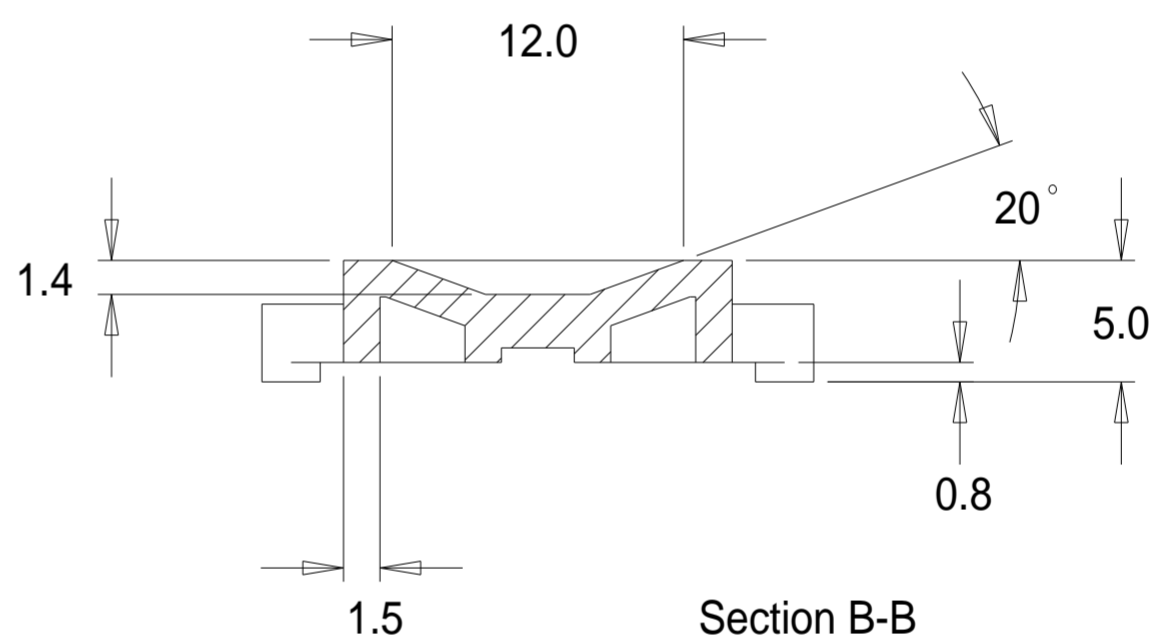
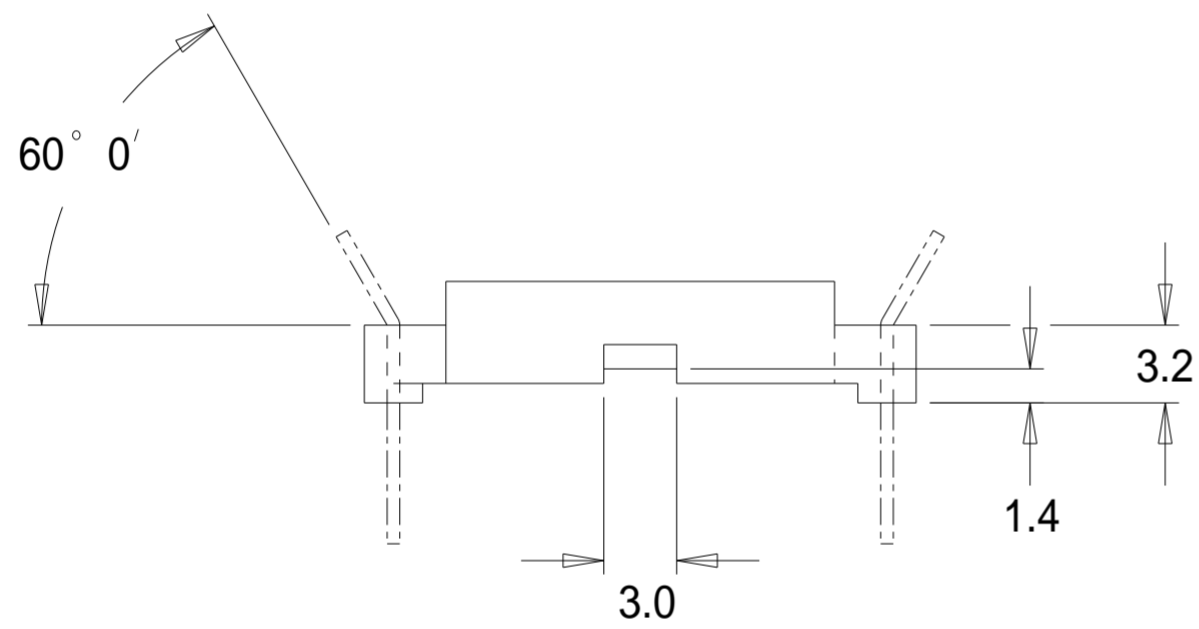
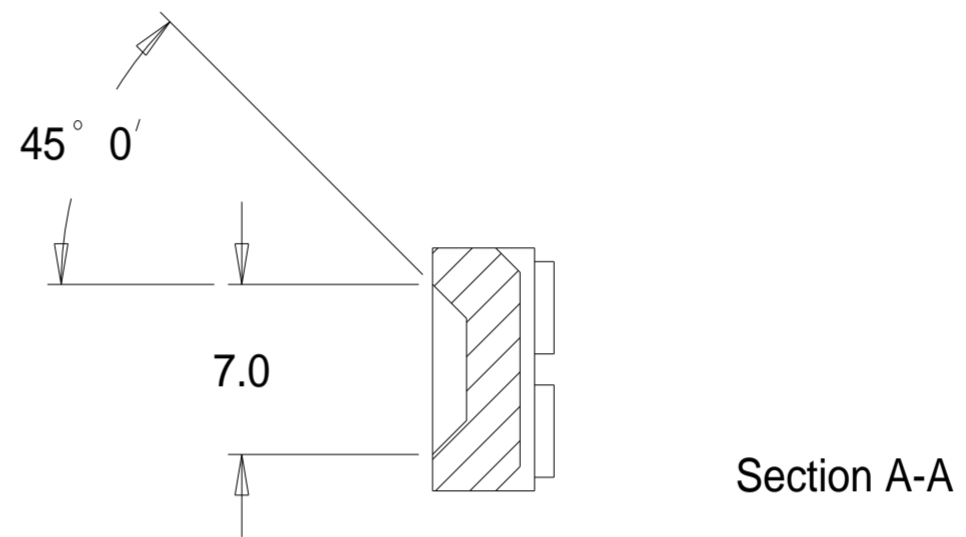
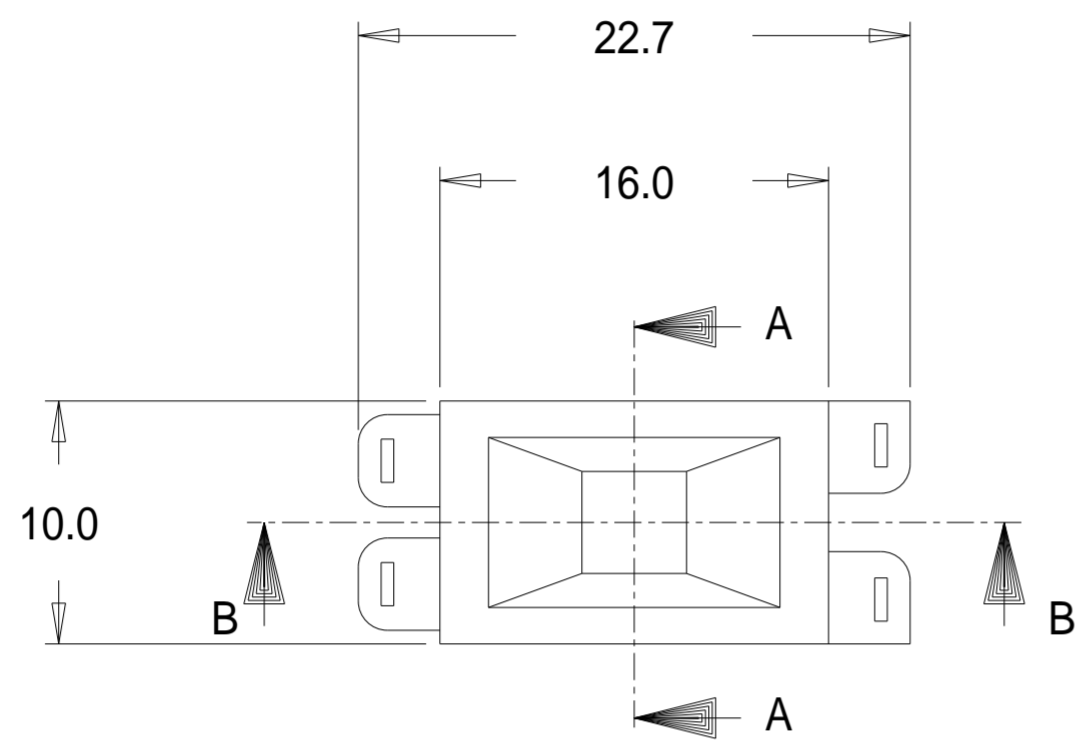